

Oceanis 46.1



An International launch: Newport / Sydney / Cannes 2019

First Line carbon PAK
Grey Pearl hull
Lite Skin Performance sails



Oceanis 46.1



An International launch: Newport / Sydney / Cannes 2019



Oceanis 46.1

An International launch: Newport / Sydney / Cannes 2019

A bestseller is born:

The Oceanis 46.1 is the ideal design to successfully follow up the iconic Oceanis 45, which has an impeccable track record. She retains the fundamental elements, which have proved such a hit among our clients, such as volume and comfort, whilst harmoniously integrating the codes that make the 51.1 so popular: innovative hull, improved performance and elegance.

An extremely well-designed boat to guarantee a long career that extends far beyond the others.



Provisional Specifications *(Boat in process of certification)*

GENERAL SPECIFICATIONS

• L.O.A	14,60 m / 47'11"
• Hull length	13,65 m / 44'9"
• L.W.L.	13,24 m / 43'5"
• Beam	4,50 m / 14'9"
• Deep draft (Cast iron)	2,35 m / 7'9"
• Deep ballast weight	2 735 kg / 6,028 lbs
• Shallow draft (Cast iron)	1,75 m / 5'9"
• Shallow ballast weight	3 061 kg / 6,746 lbs
• Performance draft (Cast iron/Lead)	2,65 m / 8'8"
• Ballast weight performance	2 576 kg / 5,678 lbs
• Air draft	20,31 m / 66'8"
• Air draft (Mast Performance)	21,31 m / 69'11"
• Light displacement	10 597 kg / 23,356 lbs
• Fuel capacity (standard)	200 L / 53 US Gal
• Fuel capacity (Option)	200 L / 53 US Gal
• Fresh water capacity (standard)	370 L / 98 US Gal
• Fresh water capacity (Option)	200 L / 53 US Gal
• Engine power (standard)	57 HP / 57 HP
• Engine power (Option)	80 HP / 80 HP

- Naval Architect: Pascal Cong
- Outside & interior design: Nauta Design

STANDARD SAILS DIMENSIONS

• Furling mainsail (standard)	44,50 m ² / 479 sq/ft
• Self-tacking jib (standard)	44,1 m ² / 441 sq/ft
• Classic mainsail	54 m ² / 581 sq/ft
• Furling genoa (105 %)	58 m ² / 624 sq/ft
• Code	0 102 m ² / 1,098 sq/ft
• Asymmetrical spinnaker	152 m ² / 1,636 sq/ft
• I	17,72 m / 58'2"
• J	5,7 m / 18'8"
• P - Roller furling mast	16,57 m / 54'4"
• P - Classical mast	16,82 m / 55'2"
• E	5,630 m / 18'6"

PERFORMANCE (Extended classic mast)

• Classic mainsail	58 m ² / 624 sq/ft
• Genoa	62 m ² / 667 sq/ft
• I	18,33 m / 60'2"
• J	6,3 m / 20'8"
• P	17,82 m / 58'6"
• E	5,50 m / 18'1"

Oceanis 46.1

1 boat / 3 dedicated programs



Even more volume thanks to the 51.1's innovative hull



Situated above the waterline, the chine boosts the internal volume considerably, retaining the boat's seaworthy qualities and the performance of the hull.

This increase in space is striking in the forward cabin: +50 cm / 1'8" gain in hull width compared with the Oceanis 45: the only boat of this size on the market with an owner's cabin.

Everything has been designed for optimum comfort and volume.

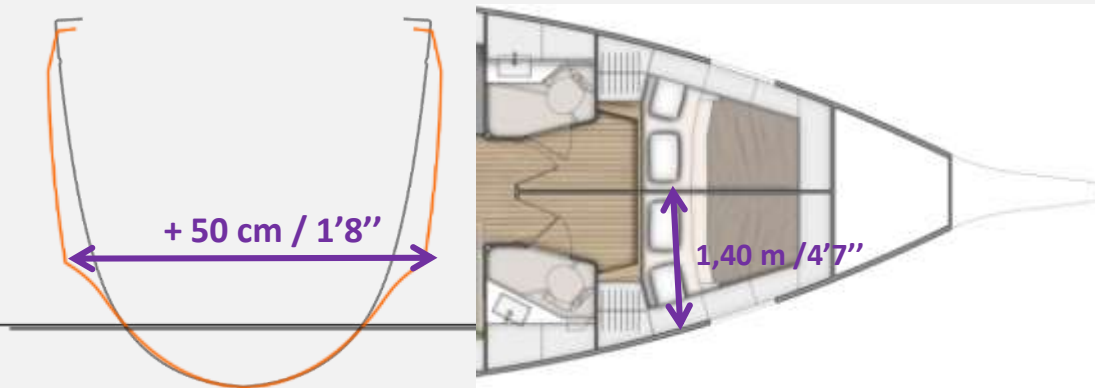

An architectural choice, which also benefits from 2 specific forward cabin options with a comfortable double bed that measures 1.40m / 4'7" at the bedhead.

A key asset for Yacht management or Charter sales

Oceanis 46.1

Hull / Deck

Easy handling : 1 self-tailing winch (H40.2 STA) at each helm station as standard: all the manoeuvres are led back to the helm station

2 Stand Up mainsheet blocks on the coachroof : for owner who wants a smoother shape.
(mainsail arch as option)

Easy handling: furling system mast and angulated boom - help for the storage of the mainsail

Polyester bowsprit with integrated anchoring gear and bobstay.
(Included in rigging packs)

Split backstay with turnbuckle

Rigid boom vang with tackle

Self-tacking jib with on-deck furler

Easy handling :
1 Self-tacking jib track

Halyard covers for a very refined deck, customizable (Blue grey or pearl grey stickers - BE V27)

Aluminium mooring cleats,
Retractable as option (BA B06)

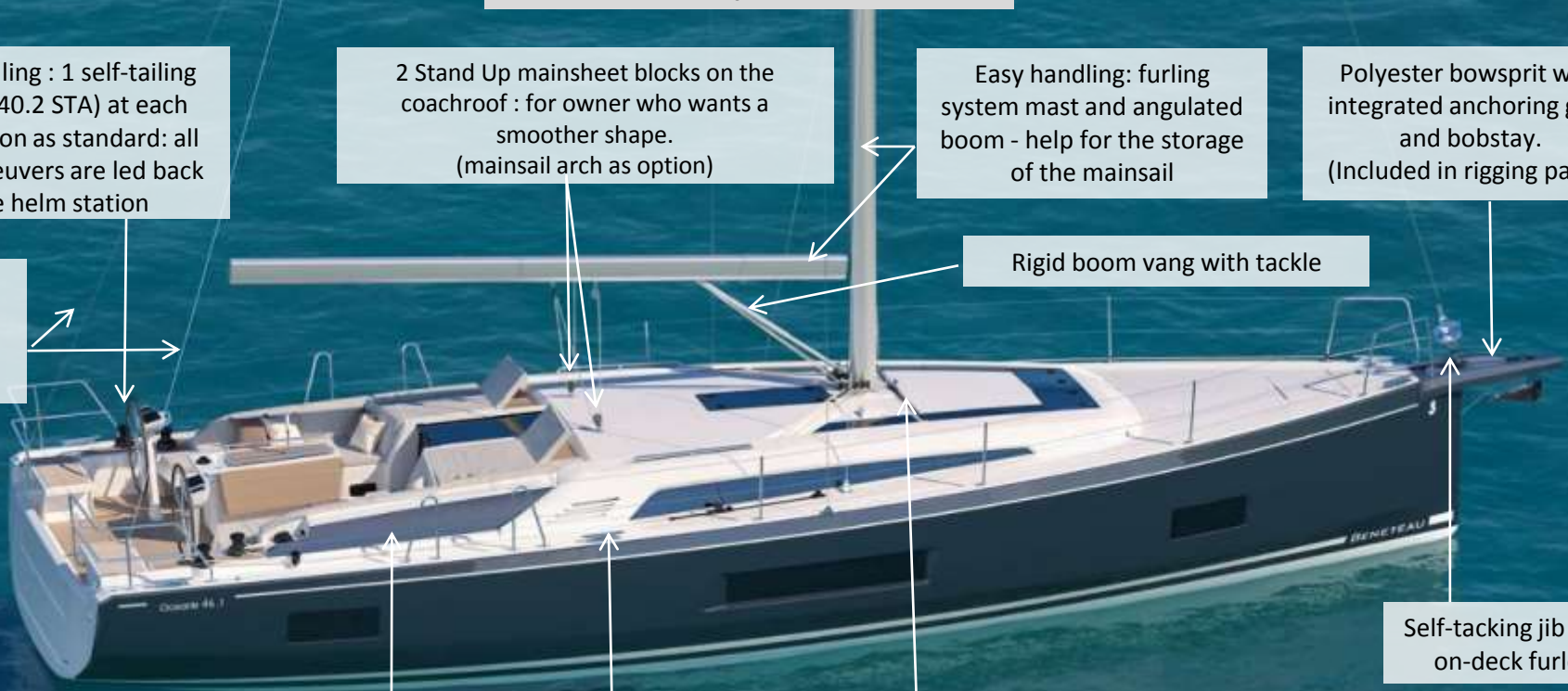

Oceanis 46.1

Easy movement in complete safety



Lower shroud fixed inside :
easy movement towards
forward

Handrails on the roof

Safety moves: Double guard
lines and stainless steel
stanchions 650 mm / 2'2"

Comfortable side decks

Oceanis 46.1

Cockpit



Mainsail arch option

Wide and very spacious cockpit to make it comfortable and easy to move around.

The sunbathing areas adjacent to the companionway considerably increase the hosting capacity and are always available for lounging.

Slatted wood as option (WE C18)

Helm console (included in electronic pack) mounted on a pedestal

Choice of 2 large cockpit tables.

Both are able to stow the life raft in the central section

2,65 m x 0,80 m / 8'8" x 2'7"

Large bathing platform with an integrated ladder
Optional electric opening.

Port helmsman's seat: integrated gas bottle stowage

Starboard helmsman's seat: integrated stowage locker

Oceanis 46.1

A unique cockpit: space, ergonomics, comfort

Cockpit seating extension with integrated rope locker (trim level)

L-shaped cockpit seating: to provide good support when heeled or for use as a lounge

3.15m / 10'4" relaxation area on each side of the cockpit!
The sunbed areas continuing on from cockpit seating are an extension of the cockpit, thus providing comfortable additional space aboard for guests. A choice, which enables a large fixed cockpit table that is always able to be used

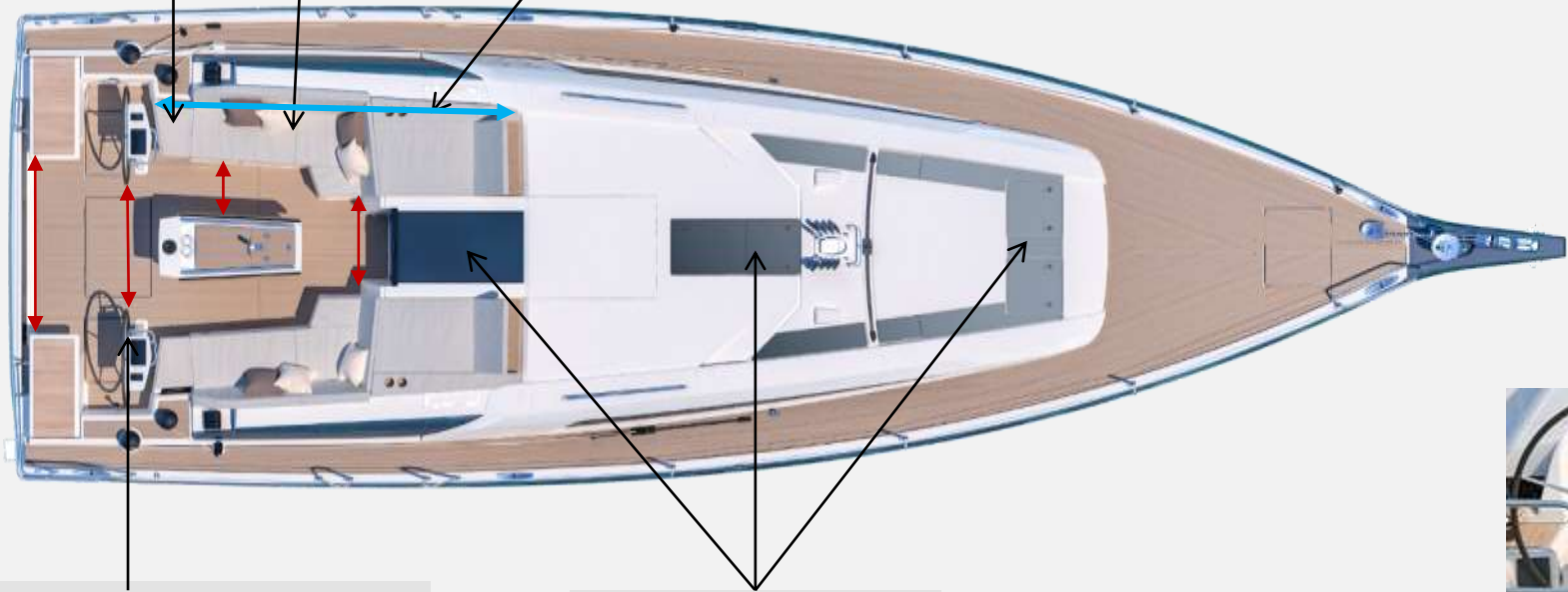

Wide passageway for very free circulation across the whole cockpit: access to the platform, between the wheels, around the cockpit table and near the companionway

Large windows for excellent interior light.
3 opening deck hatches

Wheel on a standard pedestal:
the console is integrated with the electronic instrument packs



Oceanis 46.1

Cockpit

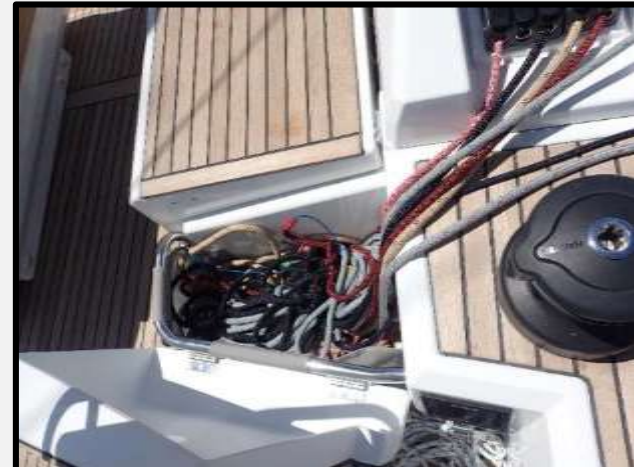

Cockpit: Electronic Packs



Helm console with Coastal Pack

COASTAL PACK

- Starboard steering console: 1 Multifunction touchscreen Zeus 7" wide wireless (GPS, Chart plotter, Chart reader - Navionics Silver cartography included)
- Windex Windvane
- Wind Sensor (Windvane, Anemometer)
- Sensor (Log, Speedometer, Temperature)
- NAC3 autopilot + Starboard helm console control
- Fixed V50 VHF, AIS receiver function
- Protective cover (Cadet Grey):
- To starboard: Steering wheel & console - to port: Steering wheel



with Coastal + Offshore Packs

OFFSHORE PACK (implies Coastal pack)

- Port steering console: 1 Multifunction touchscreen Zeus 7" wide wireless, 1 Triton² display
- WR10 Wireless autopilot remote control
- PC interface
- Protective cover (Cadet Grey): Steering wheel & console

FASNET PACK (requires a First Line pack / Coastal pack mandatory)

- 3 Mast foot repeaters
- AIS 500
- H50 Wireless VHF set

Oceanis 46.1

Cockpit: comfort options

Companionway sunbeds with removable upholstery (option) : can be very easily moved on fore deck

Clever: sunbeds with tilting backrest and integrated cup holders



2 choices for exterior upholsteries

- Dolce 51 seats (BS C0591)

Or

Dolce 51 cushions and backrests
+ 2 Companionway sunbeds (BS C3691)



Cockpit: comfort options



Gas cockpit plancha option (GO P01)

Increase the welcome capacity : add a long seat beside helmsman :
0,80m x 0,47m / 2'7" x 1'7"

Smart : rotates toward the aft platform for an ergonomic position and to
use it without bothering the life in the cockpit.

Handrail on the side to cook in complete safety



Oceanis 46.1

Cockpit: comfort options

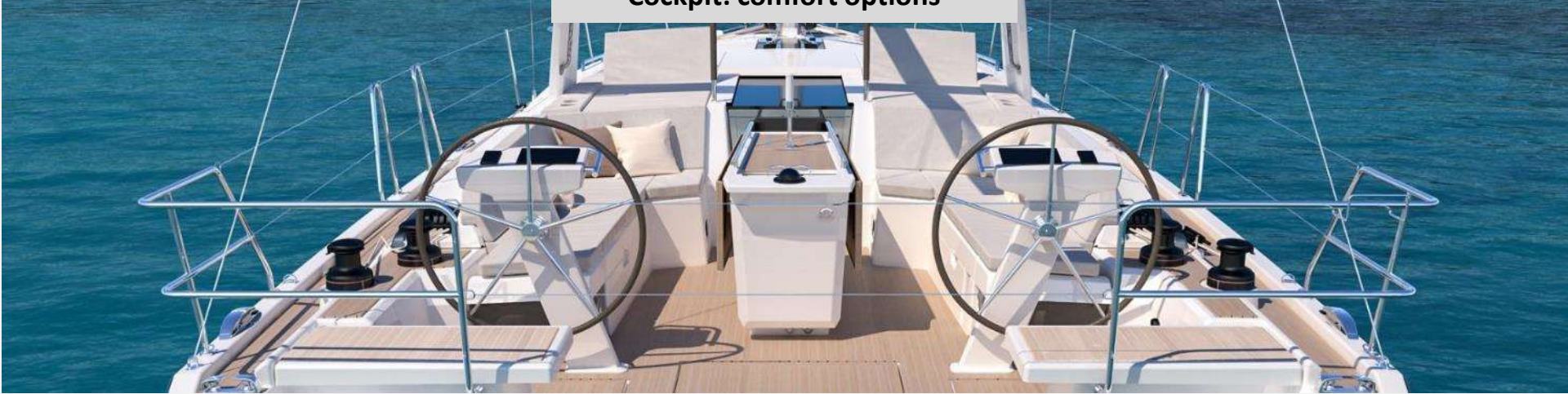

"Luxe" cockpit table option (BE T17)

"Luxe" polyester/wood cockpit table + protective cover (Cadet Grey), stainless steel handrails, lighting, central storage (15 L / 4 US Gal)

The storage can be converted as cooler with the refrigerating unit as option

Liferaft storage in the central section

'Luxe' cockpit table included in Charter trim level with polyester flaps for an easier maintenance



Dimensions:

central section dimension =
1,30 m x 0,50 m / 4'3" x 1'8"

Wooden leaves =
1,10 m x 0,40 m / 3'7" x 1'4"

Opened width =
1,35 m / 4'5"

Cockpit: comfort options

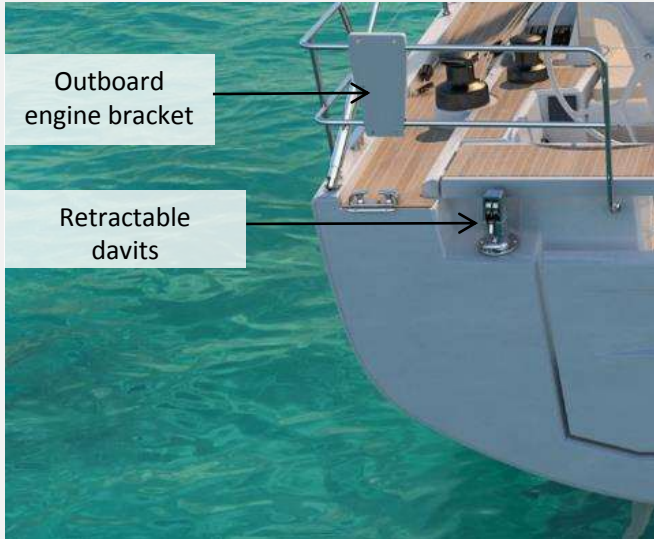

TENDER PACK (P B11)

- Retractable davits
(Max. tender length: 3,10 m / 10'2", Maximum load: 130 kg / 287 lbs)
- Electric inflater / deflater
- Outboard engine bracket

A convenient solution for the dinghy stowage



Cockpit: comfort options

EXTERIOR PROTECTIONS LUXE CADET GREY

2 Versions: with and without mainsail arch

- Sprayhood with large Extra-Clear windows provide excellent visibility (BE CLA66 / BE CL166)
- Bimini delivered with shading canvas and LED lighting (BE IL 166 / BE IL A66)
- Aft enclosure option (BE FL 166) : allows the cockpit to be a full time additional living area whatever the weather is (no visual)



NEW RIGGING PACKS: FOR EASIER ORDERS AND BETTER UNDERSTANDING

1

FURLING MAST
(Standard boat)



OR

CLASSIC MAST PACK
With mainsail and lazy
bag

OR

FIRST LINE

Boat delivered without
sails.

2

Upwind pack



OR

Downwind pack

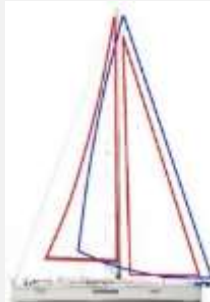

OR

Upwind + Downwind
pack

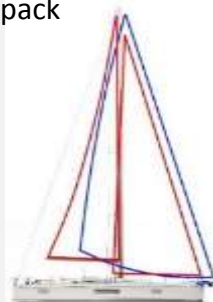

+

Rigging equipment
already included in
First Line Packs

Performance sails
available as option

1. Chose your mast: furling/
classic/ Performance
2. Chose 1 rigging pack
according your customer's
navigation program

Packs are thought to fit to all
the navigation programs:

Upwind pack : for use of genoa

Downwind pack : for use of
Code 0 or spinnaker

Upwind & Downwind pack : for
a full configuration, this pack
associates all the equipment

	Downwind Pack	Upwind Pack	Downwind & Upwind Pack
• Symmetrical spinnaker rigging	YES	NO	YES
• Genoa sheet tracks on side decks	NO	YES	YES
• German system (Two-way mainsheet at the helm station)	YES	YES	YES
• 2 Genoa winches (H50.2 STA)	YES	YES	YES
• 2 Additional halyard clutches	YES	NO	YES
• Polyester bowsprit with integrated anchoring gear and bobstay (for Code 0 and asymmetric spinnaker)	YES	NO	YES
• Furling Dacron genoa (to replace the standard self-tacking jib)	NO	YES	YES

CLASSICAL MAST PACK (compatible with all rigging Packs)

- Classical 9/10 anodised aluminium mast, 2 Spreaders
- Dacron semi Full Batten mainsail
- 2 Additional halyard clutches (to port)
- Lazy Jack and Lazy Bag in Natural colour

Oceanis 46.1

PERFORMANCE PACKS



FIRST LINE

Fast

Oceanis 46.1

FIRST LINE



BENETEAU

+28%
of sail area

! Boat delivered without sails.
Performance sails as option

TALLER
mast

HIGH QUALITY
deck hardware

LIGHTER
bulb
DEEPER
keel

Fast



Delivered without sails. Optional sails (Lite Skin) available as option

Sail surfaces : Classic mainsail (58 m² / 624 sq/ft), Genoa (62 m² / 667 sq/ft)

FIRST LINE

Alu

Carbon

	Alu	Carbon
<ul style="list-style-type: none"> • Polyester bowsprit with integrated anchoring gear and bobstay (for Code 0 and asymmetric spinnaker) 		✓
<ul style="list-style-type: none"> • Performance Classical mast, 2 Aft swept spreaders (+ 1 m / 3'3"). Track + Main sail ball traveller 	Aluminium mast (Z Diffusion)	Carbon mast (Axxon)
<ul style="list-style-type: none"> • Textile hydraulic backstay 		✓
<ul style="list-style-type: none"> • Black anodised aluminium boom 	x	✓
<ul style="list-style-type: none"> • Cathedral type Dyform standing rigging 		✓
<ul style="list-style-type: none"> • Flatdeck genoa furler 		✓
<ul style="list-style-type: none"> • 4 Additional halyard clutches (2 to starboard + 2 to port) 		✓
<ul style="list-style-type: none"> • Performance running rigging, Dyneema (Mainsail, Genoa, Code 0, Asymmetrical spinnaker, Halyards) 		✓
<ul style="list-style-type: none"> • German system (Two-way mainsheet at the helm station) 		✓
<ul style="list-style-type: none"> • Harken pulleys upgrade - 12 Black Magic, 8 ESP (in lieu of standard) 		✓
<ul style="list-style-type: none"> • Genoa sheet tracks on side decks + Complete genoa rigging (Genoa sheets, Return pulleys) 		✓
<ul style="list-style-type: none"> • Performa winches upgrade (1 Port electric H46.2 STPEH rigging winch (Halyards) + 1 Starboard manual H46.2 STP rigging winch + 2 Manual H50.2 STP genoa sheet winches) 		✓
<ul style="list-style-type: none"> • Composite steering wheels 	White	Black

Oceanis 46.1

The interior living areas

A big name in design for a particularly elegant interior.

Nautica Design, always mindful to giving our owners the very best, has managed to combine the beauty of fabric and materials, omnipresent light, ergonomics and volume.

A very rich standard in the line of owners' boats.

Mast bookcase, dedicated chart table, large U-shaped sofa, edge capping on the furniture, beige deck linings along the hull, indirect LED lighting, mast upholstery, handrails, view of sea through large ports, easy access with an extremely soft and comfortable companionway.... The 46.1 is an exemplary model

Personalisation certainly isn't overlooked either. Alpi Mahogany woodwork for a timeless classic or light scrubbed Oak for a more modern twist.

Available with lining and upholstery options creating a boat that appeals to all.



Oceanis 46.1

Interior: a very qualitative standard



Everywhere natural light

Long handrail on ceiling

Starboard head compartment access

Large storage volume. High cupboards on each side.

Beige padding upholstery as standard

Mirror on bulkhead down the companionway

Large saloon table
1,32m x 0,85m / 4'4" x 2'9"
Double berth as option

L-shaped galley : 3C2T layout

Very comfortable upholstery
Large choice of color and material : fabrics, leather and ultraleather

Oceanis 46.1

Interior: very qualitative standard

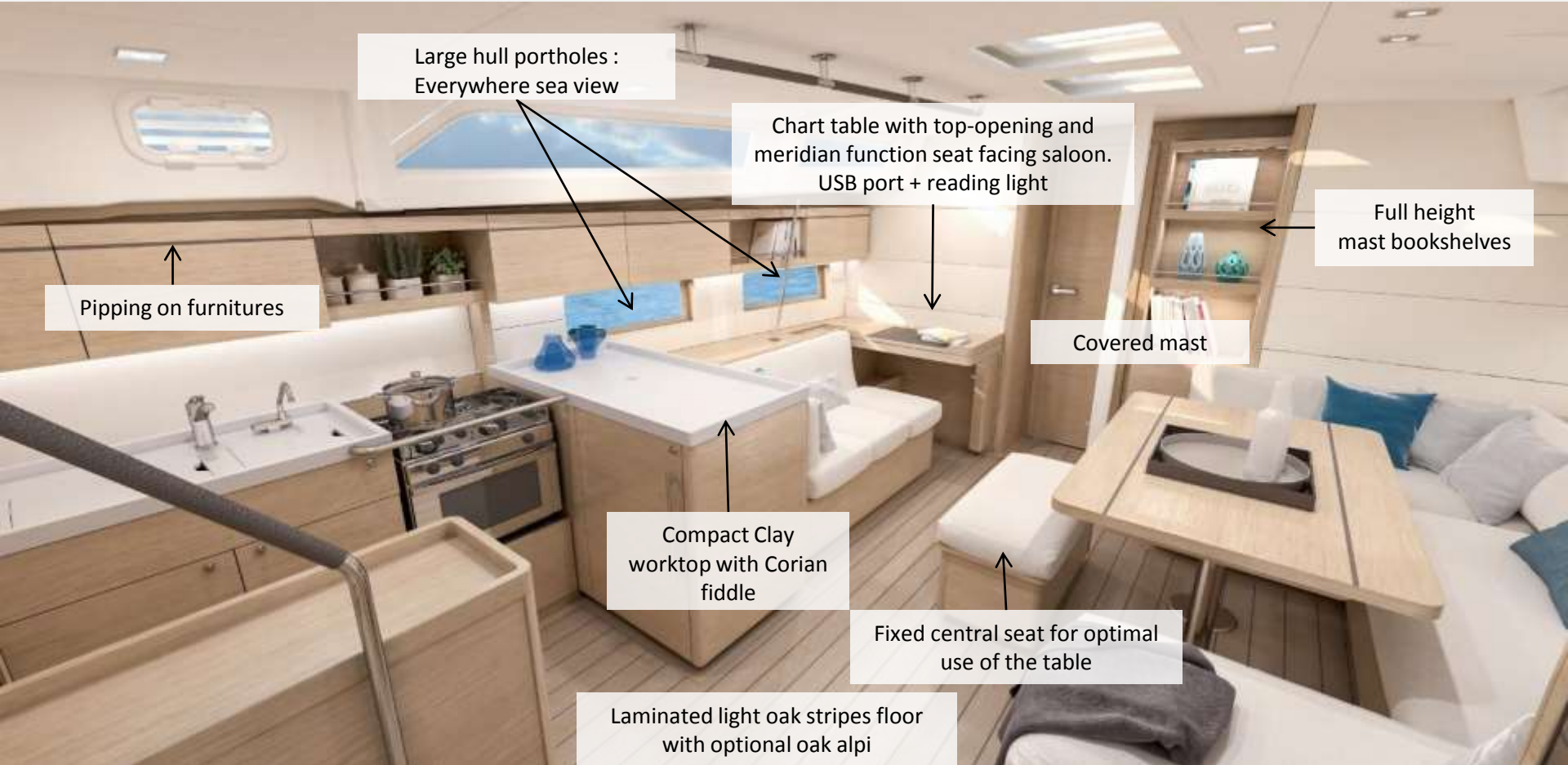

Oceanis 46.1

Interior: very qualitative standard



Oceanis 46.1

Galley: qualitative equipment and large volume of storage

Airy : Opening porthole

Closed high cupboards

20 L / 5 US Gal Micro wave oven
IA F02 / F03 (optional)

Stainless steel sink 2 rectangular basins - Clay
compact sink cover (with cutting board
function)

2 burners - Stainless steel oven
(grill included in Comfort trim level)

85 L – 22 US Gal Icebox
(with refrigeration unit included in
Comfort trim level)

Low unit : 1 drawer, 2 doors

Bin

130 L refrigerator (12 V)
with front opening

Clay Worktop
with Corian fiddle



Oceanis 46.1



BENETEAU

Galley: qualitative equipment and large volume of storage



Oceanis 46.1

Owner cabin: an unmatched volume and an high-end equipment as standard



Oceanis 46.1

Owner cabin: an unmatched volume and an high-end equipment as standard



Oceanis 46.1

Aft cabins: to welcome guests in full comfort



Bedhead facing aft for a complete comfort

Large volume of storage
1 wardrobe, 2 closets, 1 cupboard

Sea view
from the
bed

Double berth :
2,05 x 1,40m / 6'9" x 4'7"

Headroom : 1,92m / 6'4"

An unbeatable Charter offer

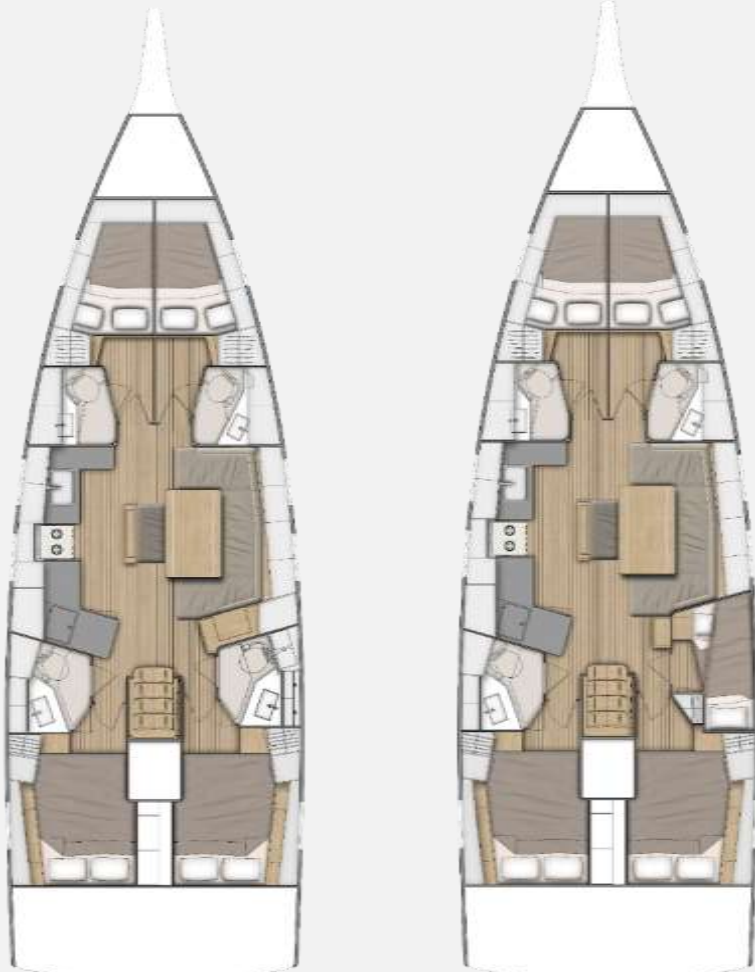

4C4T

5C3T

The exceptional interior volume of the 46.1 enables some highly attractive and unique versions:

- Double forward cabins with forward facing bedheads twinned with a large bunk:
Length: 2.00m / 6'7"
Bedhead width: 1.36m / 4'6"
Width at foot of bed: 1.16m / 3'10"
Large storage volume: high cupboards, 1 wardrobe, drawer under bed)
Each cabin has its own head!
- Side galley opposite the saloon: large work surface, spacious stowage: designed for meal preparation with numerous guests.
- In the 4C4T version: chart table to starboard near the companionway
- A 5-cabin version on a 46'!
The starboard head and chart table are replaced by a side cabin with bunk beds.
Perfect for the youngest members of the crew

An unbeatable Charter offer

Private head compartment



Sea view from the bed



Large storage volume: high cupboards, 1 wardrobe, drawer under bed



Double forward cabins : spacious et bright

Oceanis 46.1

An unbeatable Charter offer



Lower bed (2,00 m x 0,60 m - 0,42 m /
6'7" x 2' - 1'5")

Upper bed (2,04 m x 0,67 m - 0,53 m /
6'8" x 2'2" - 1'9")

Storage

Side cabin with bunk beds

Oceanis 46.1

An unbeatable Charter offer



Oceanis 46.1

An unbeatable Charter offer

85 L ice box with top opening.
12V refrigerating unit included in
trim level

Location for
microwave
(option)

Stainless steel cooker 2 burners
& oven on gimbal. Grill included
in trim level

Hughe side galley

Large double sink, compact Clay cover
with cutting board

Convenient bin: with access from the top of the worktop

Storage unit :
1 cutlery storage drawer, 1 door, 2 shelves

130 L fridge, with
front opening

Large low storage unit or optional 6
persons dish-washer (IA L04 / 05)

Large full-height
storage. Location
for washing
machine in the
low part

Central unit with bottle holder function. Location for the
optional 32" LED TV on lifting system (RH 32E)

Fixed 2 persons central bench

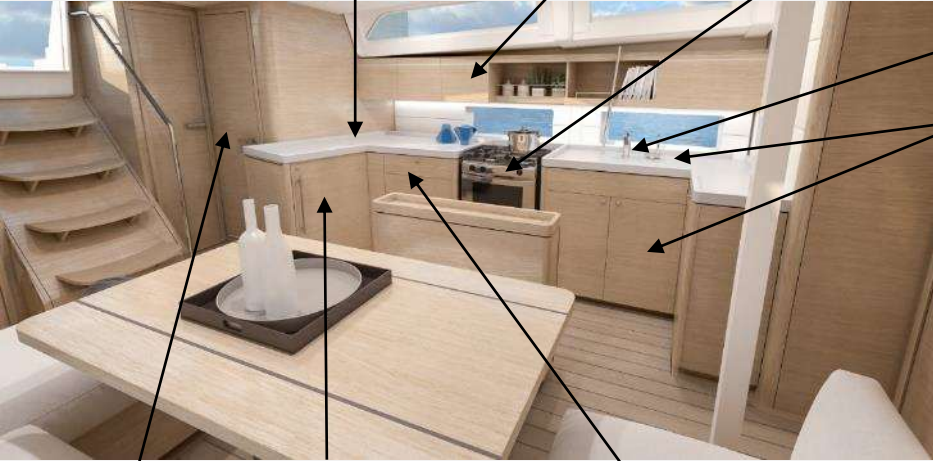

Interior customization

STANDARD

WOOD



Alpi Mahogany

+

FLOORS



Laminated type
« parquet »

UPHOLSTERY

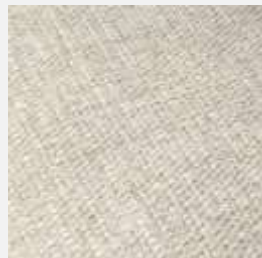

Néo 05 -
STANDARD

PADDING



Beige -
STANDARD

OPTIONS



Brushed oak /

+



Laminated light oak stripes /



Lounge - Winner
Silver 139 - **OPTION**

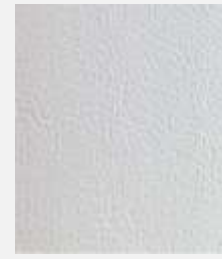

PVC Marlin Weiss
OPTION



Macadamia -
OPTION



Anthracite -
OPTION

! Brushed oak alpi not offered for US market. Replaced by satin light oak

Interior customization

Luxe upholstery

ULTRALEATHER - OPTION

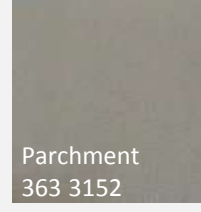
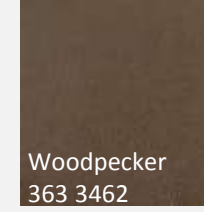
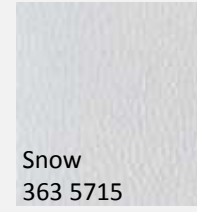
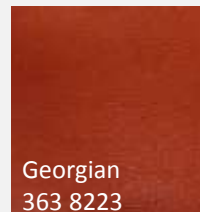
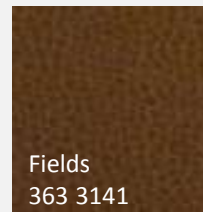
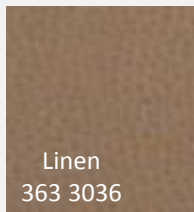
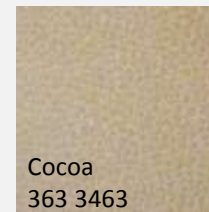

LEATHER - OPTION

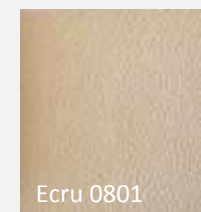
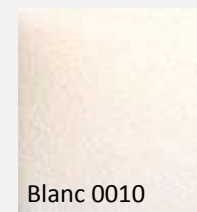
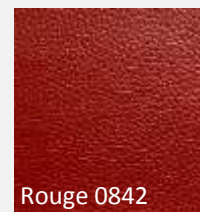
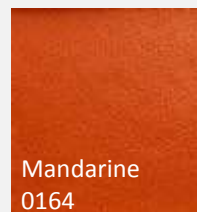
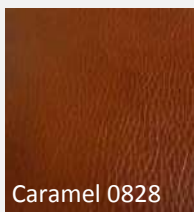
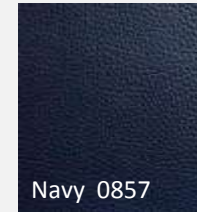
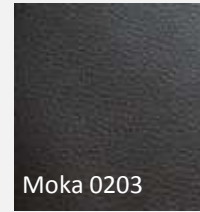
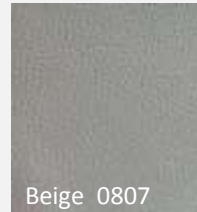

Oceanis 46.1



BENETEAU

Offered layouts



3C2T



3C3T



4C4T



5C3T

Useful dimensions

Cockpit – Deck
Saloon
Galley
Cabins
Heads

Oceanis 46.1

Exterior dimensions

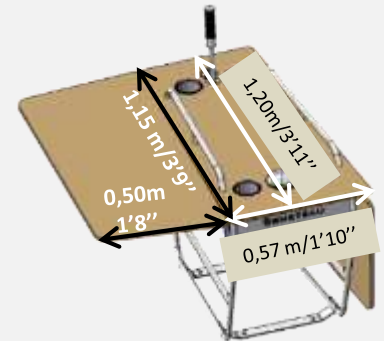

Standard table
Folded dimension =
1,20 m x 0,57 m / 3'11" x 1'10"
Wooden leaves =
1,15 m x 0,50 m / 3'9" x 1'8"
Opened width =
1,57 m / 5'2"



Luxe table
Folded dimension =
1,30 m x 0,50 m / 4'3" x 1'8"
Wooden leaves =
1,10 m x 0,40 m / 3'7" x 1'4"
Opened width =
1,35 m / 4'5"

Oceanis 46.1

Interior dimensions

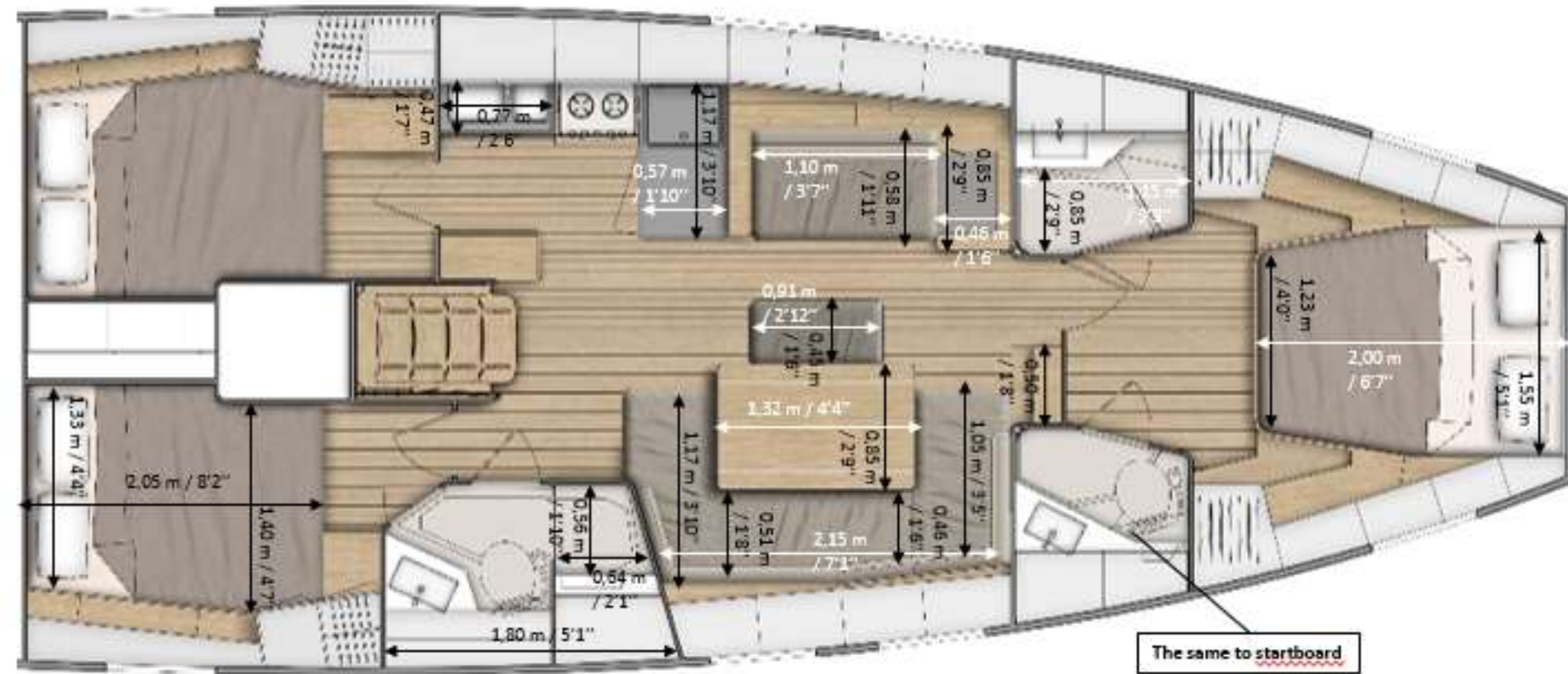

Oceanis 46.1

Interior dimensions

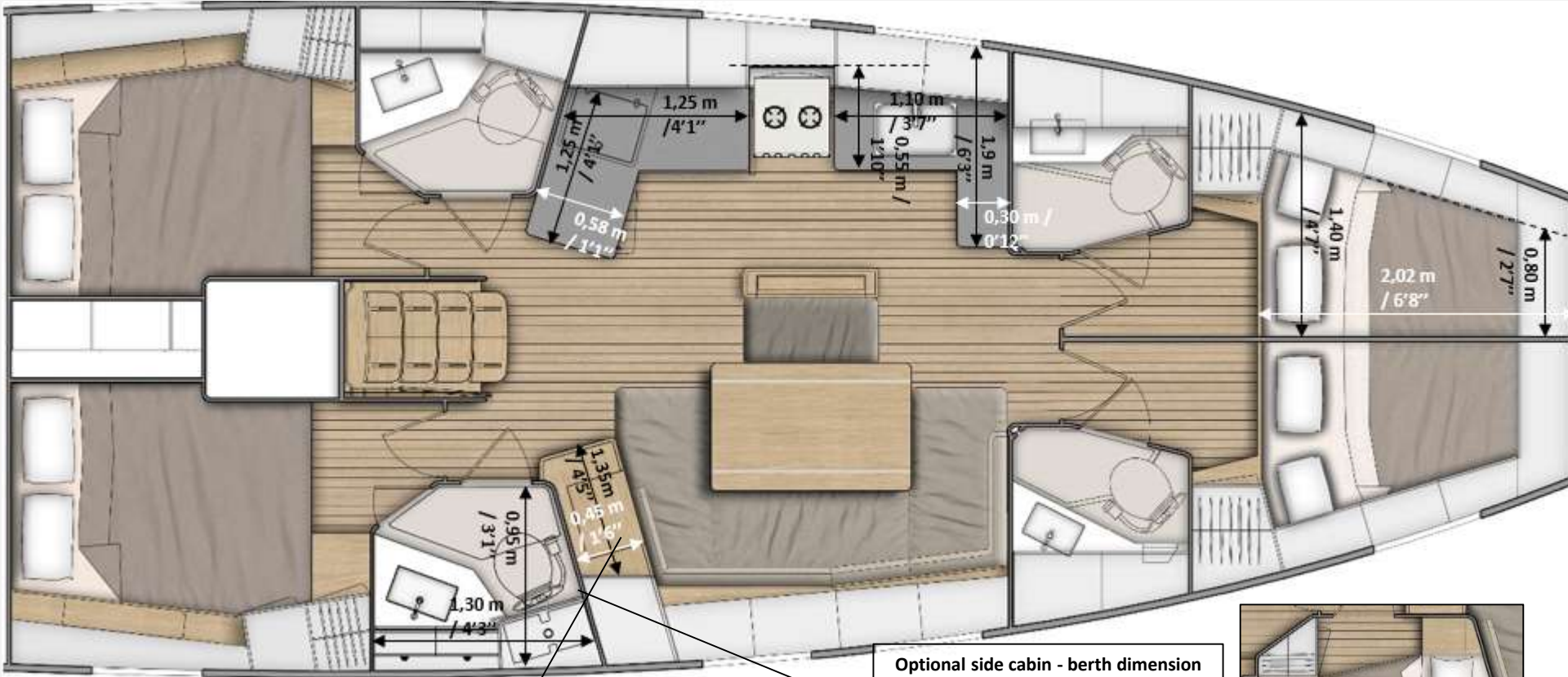

Opening top :
0,53 m x 0,35 m / 1'9" x 1'2"

Optional side cabin - berth dimension
Lower bed :
Head : 0,60 m / 1'12"
Foot : 0,42 m / 1'5"
Length : 2,00 m / 6'7"

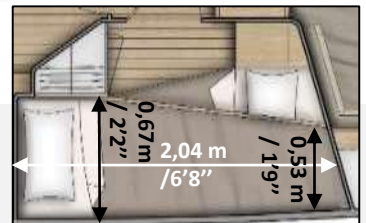

Oceanis 46.1

Headrooms

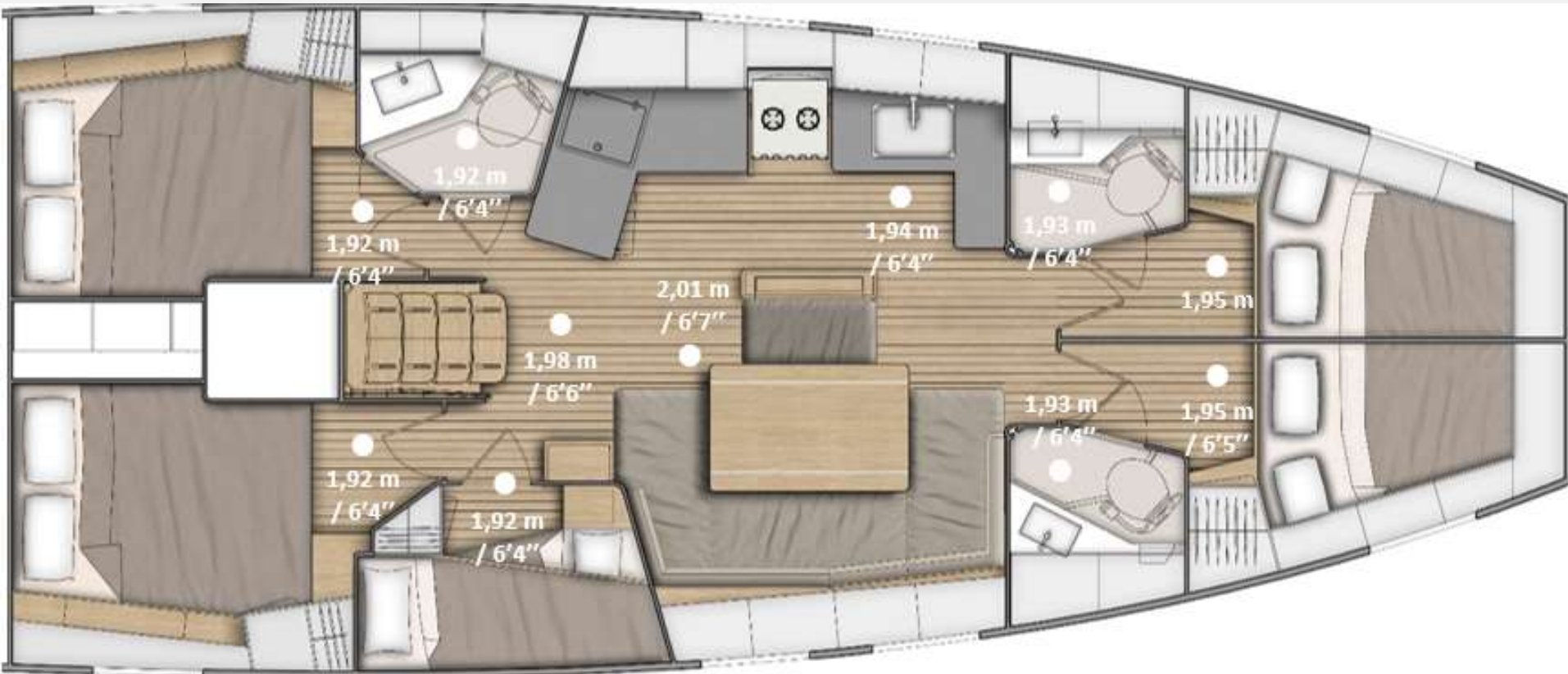

Comfort equipments

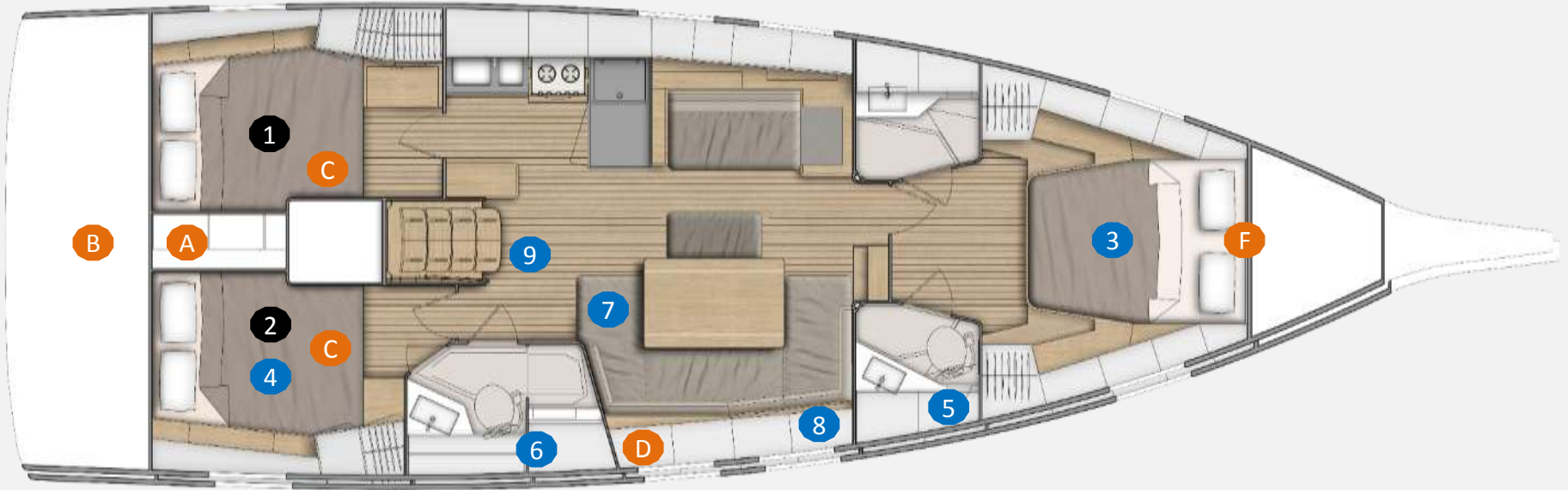

- 3 Fresh water tank 330 L / 87 US Gal – standard
- 4 Fresh water tank 200L / 53 US Gal - **option**
- 5 Holding tank - 50 L / 13 US Gal standard
- 6 Holding tank - 64 L / 17 US Gal standard
- 7 Electric water heater 40 L / 11 US Gal - standard
- 8 Plumbing board (accumulator tank- water units....)
- 9 Water maker 60 L/h – 16 US Gal/h - **option**

- 1 Fuel tanks 200 L / 53 US Gal - standard
- 2 Fuel tanks 200 L / 53 US Gal – **option**
- A Generator 7,5 KVA 230V / 50 Hz – **option**
- B Inverter 12V / 230V - **option**
- C 2 service batteries 120 Ah – 1 engine battery 120 Ah - standard
- D Electrical panel
- F Bow thruster (+ battey)- **option**

Oceanis 46.1

Air heating

3C2T

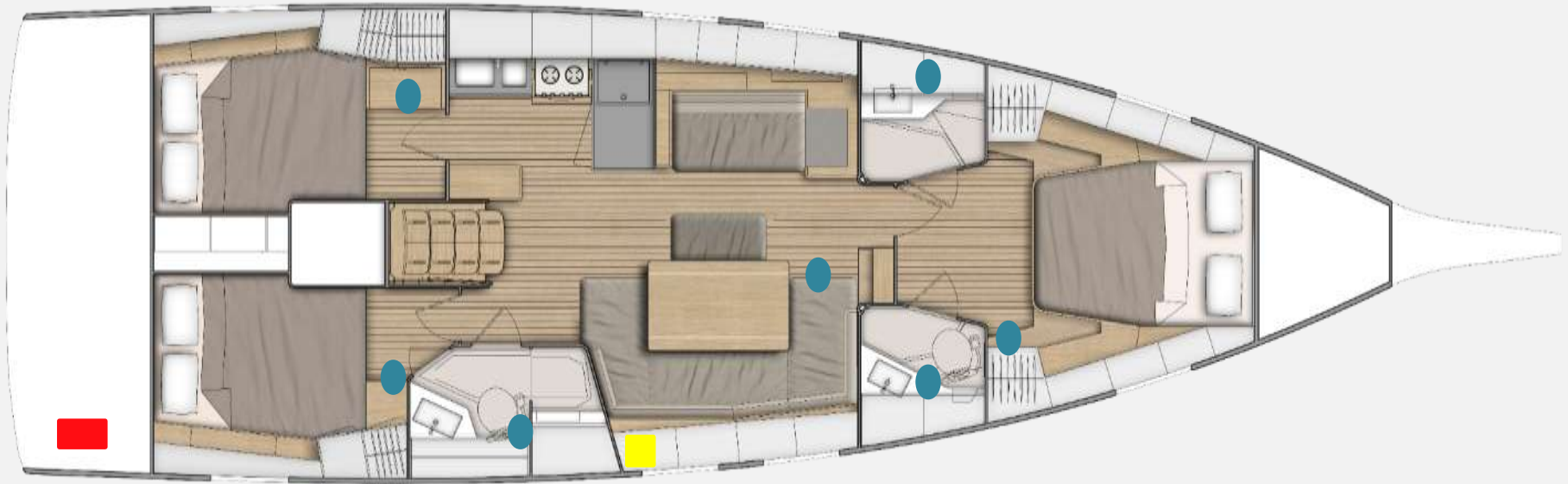

 Boiler 5 500 W

 Thermostat





 Hot air outlet

Oceanis 46.1

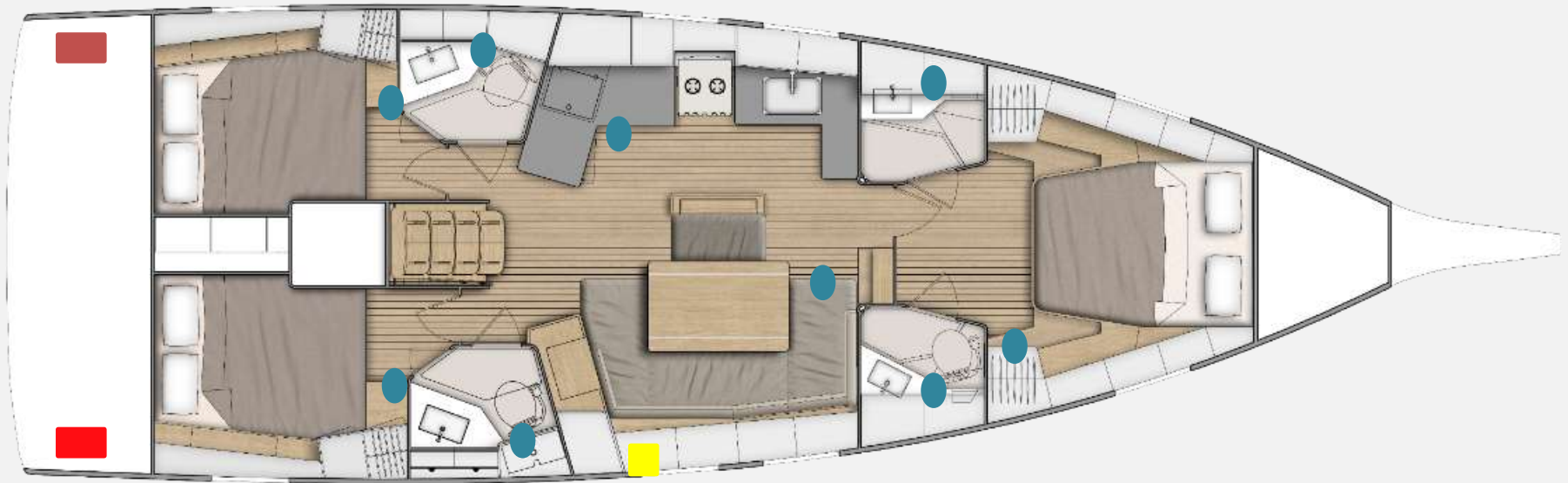
Air heating

3C3T







-  Boiler 3 900 W
-  Boiler 5 500 W
-  Thermostat
-  Hot air outlet

Oceanis 46.1

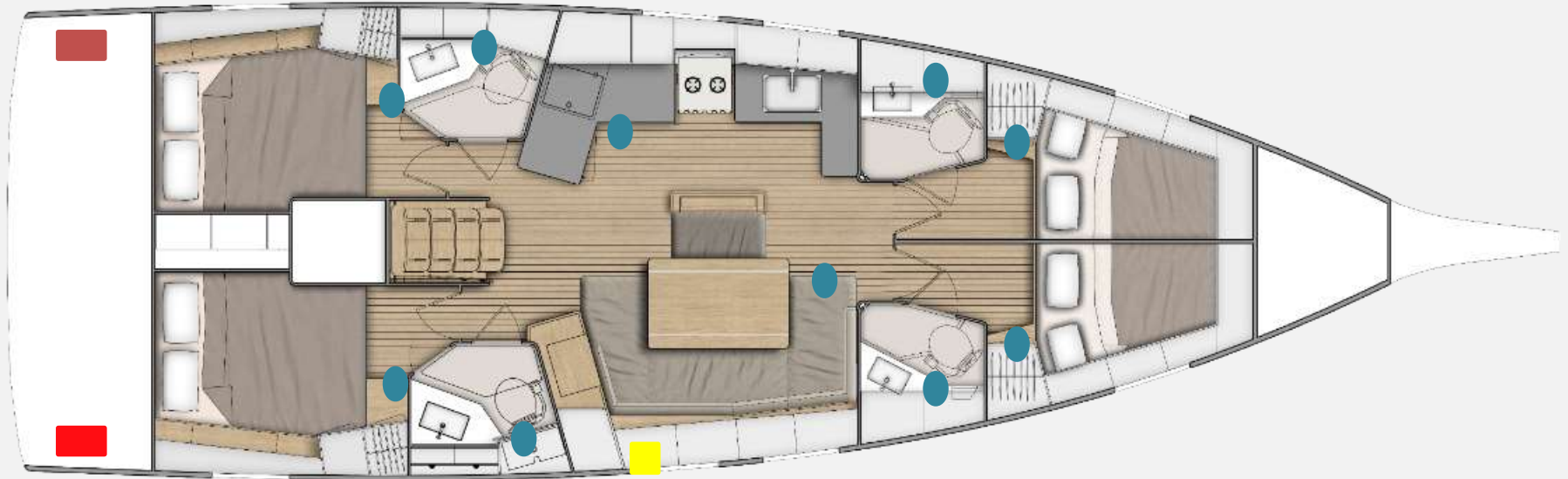
Air heating

4C4T







-  Boiler 3 900 W
-  Boiler 5 500 W
-  Thermostat
-  Hot air outlet

Oceanis 46.1

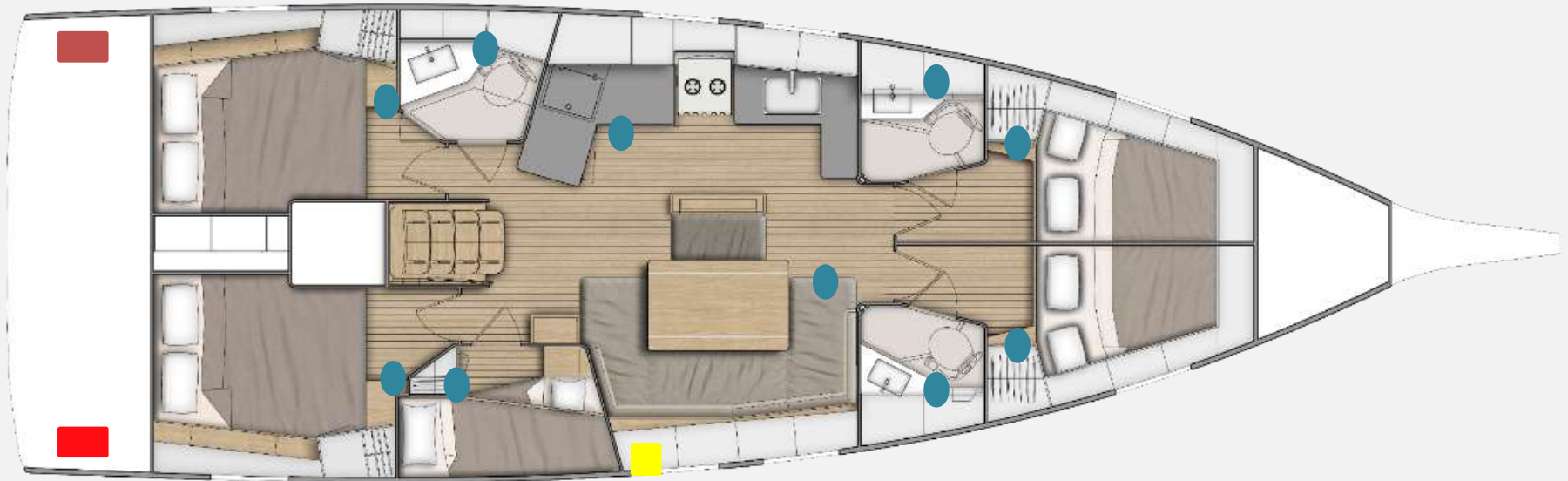
Air heating

5C3T





-  Boiler 3 900 W
-  Boiler 5 500 W
-  Thermostat
-  Hot air outlet

Air conditioning

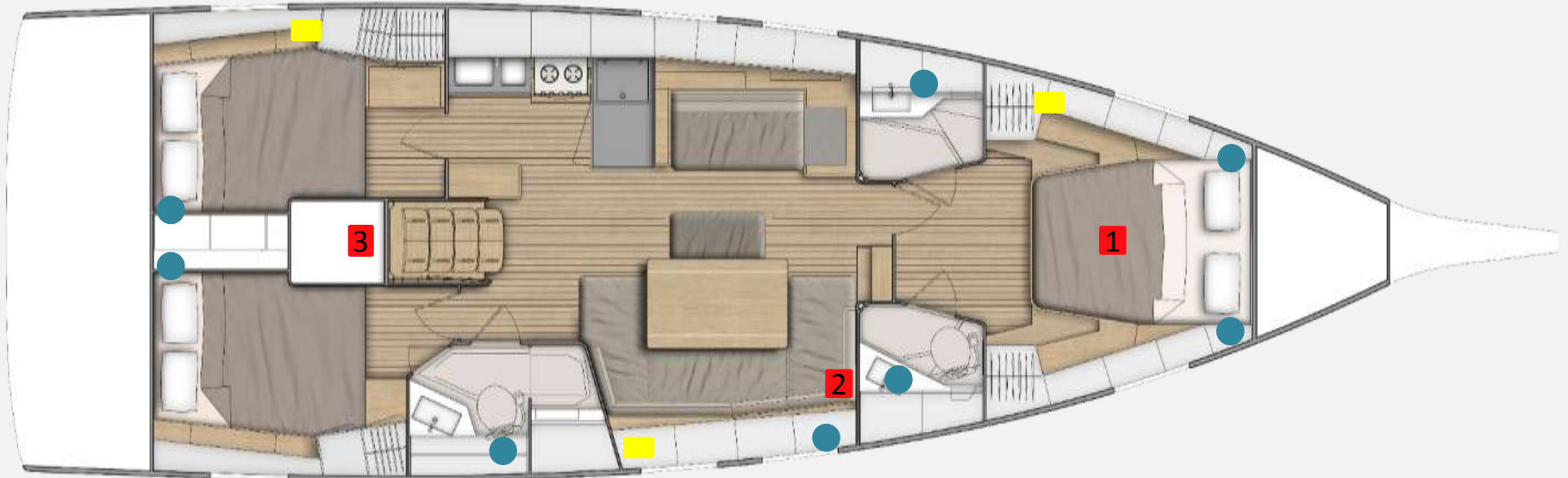
3C2T



- 1** Air conditioning unit 8 000 BTU
- 2** Air conditioning unit 16 000 BTU
- 3** Air conditioning unit 12 000 BTU

-  Thermostat
-  Air conditioning outlet



Oceanis 46.1

Air conditioning

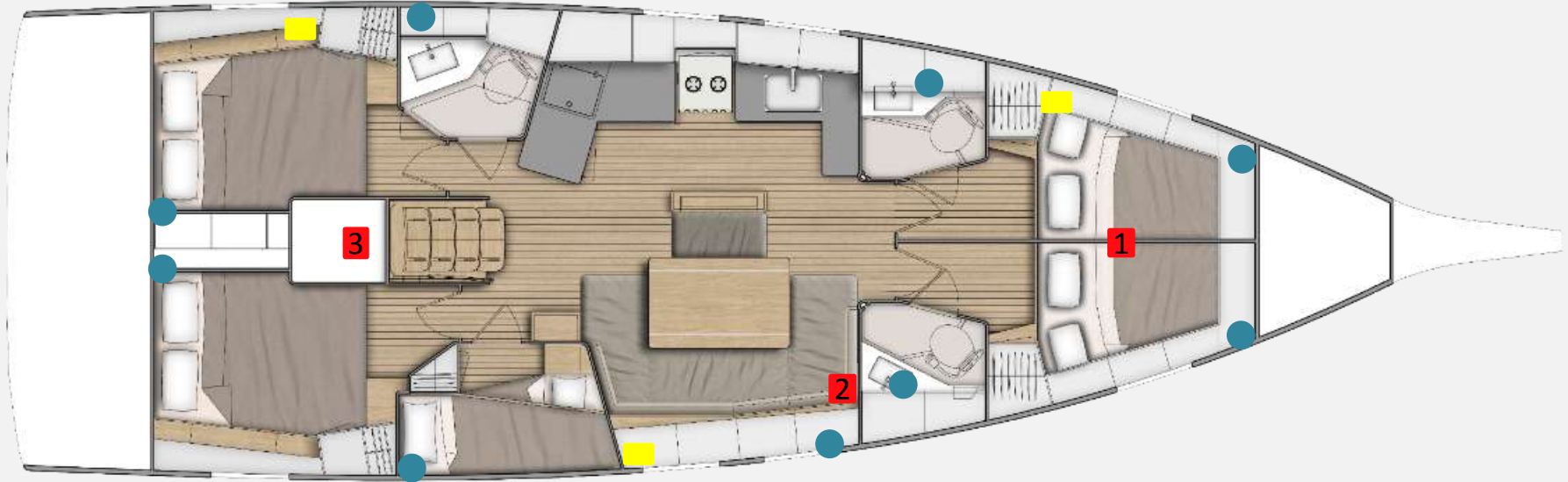
5C3T



- 1** Air conditioning unit 8 000 BTU
- 2** Air conditioning unit 16 000 BTU
- 3** Air conditioning unit 12 000 BTU

-  Thermostat
-  Air conditioning outlet